



AC-SLIM AC-MAX

36 BAY SECURE SMART CHARGING CART

The **AC-SLIM** is designed to charge & store up to 36 Chromebooks, Laptops or tablets up to 15".
 The **AC-MAX** is designed to charge & store up to 36 Laptops from to 15.6" to 17".
 Please review this guide before installing devices and to learn how to safely use your cart.

AC input: 120V AC 60 Hz | **Max amps:** 14A

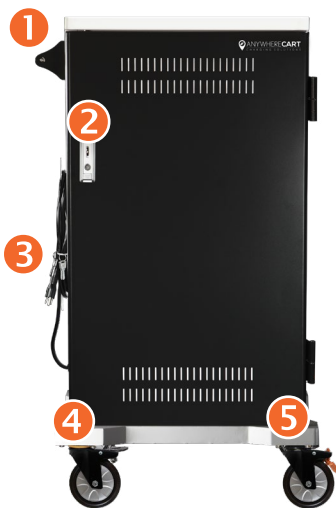

Front of Cart (closed)

- 1** Push Handle (Installation required)
- 2** Keyed Door Lock Latch
- 3** Power Cord
- 4** 5" Swivel / Lock Casters (Black tab)
- 5** 5" Swivel / Directional Casters (Orange tab)



Front of Cart (open)

- 6** Device Cord Pass-Thru
- 7** External Power Button
- 8** External Power Outlets
- 9** Removable Dividers

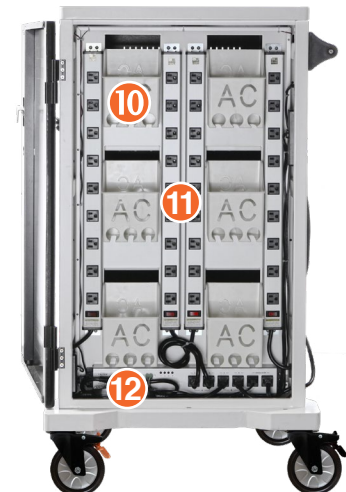

Back of Cart (open)

- 10** Removable Adapter Baskets
- 11** Power Outlet Strips
- 12** INTELLI-SENSE Smart Charger

DIMENSIONS (AC-SLIM)

Height:	44"
Width:	26"
Depth:	26"

CART CAPACITY (AC-SLIM)

Divider Spacing:	1.18"
Shelf Depth:	14.375"
Shelf Height:	10.50"

WEIGHT (AC-SLIM)

Product Weight:	183 lbs.
Shipping Weight:	217 lbs.

Specifications subject to change without notice.

 WARNING THIS IS NOT A TOY. ALWAYS FOLLOW SAFETY PRECAUTIONS.				
<p>ONLY ADULTS should move the cart.</p> 	<p>DO NOT allow children to move or climb.</p> 	<p>DO NOT ride or run with the cart.</p> 	<p>DO NOT attempt to move downstairs.</p> 	<p>DO NOT place liquids on or near the cart.</p> 

 IMPORTANT	<p>THE ELECTRICAL SYSTEM IS DESIGNED TO HANDLE A MAXIMUM OF 1400 WATTS per side. If wattage exceeds 1400W at one time, charging system may not operate correctly. Remove devices until the total wattage is under 1400W.</p>
--	--

 WARNING
<ul style="list-style-type: none"> • THIS IS NOT A TOY. CHILDREN SHOULD NEVER MOVE OR CLIMB THE CART! • ONLY ADULTS should move the cart. • NEVER climb, sit on or tilt the cart. • ALWAYS move the cart slowly and be aware of your surroundings. • ALWAYS latch doors before moving the cart. • DO NOT use the power cord to pull the cart. • DO NOT roll the cart over the power cord. • DO NOT touch any part of the electrical system while plugged in. • DO NOT place liquids on or near the cart. • DO NOT use an extension cord with this unit. • DO NOT plug in the cart if the switch, receptacles, or power cord are broken, cracked, torn or inadequately repaired. • Repairs should always be performed by a qualified electrician. • Set the power switch to the OFF position before you unplug the unit from the wall, plug the unit into the wall, or plug in devices. • If external devices are set on top of the cart, remove them before rolling cart around.

For warranty claims, please have the following information ready, then visit www.anywherecart.com/support to create a help ticket.

Serial Number:

Charging System Type:

Date Of Purchase:

Reseller Name:

PO Number:

- 1 Locate the narrow cardboard box containing the handle rod, handle bolts, mounting brackets & hex wrenches.

- 2 Locate the threaded holes for the handle. On the AC-SLIM, they are on the left side. On the AC-MAX, they are on top.



- 3 Using the larger hex wrench, attach and tighten both the left and right side handle mounting bracket to the cart using 4 large bolts.

- 4 Fit the handle rod between the bracket and tighten using the smaller hex wrench and handle bolts.

AC-SLIM



AC-MAX



THE ELECTRICAL SYSTEM IS DESIGNED TO HANDLE A MAXIMUM OF 14 AMPS.

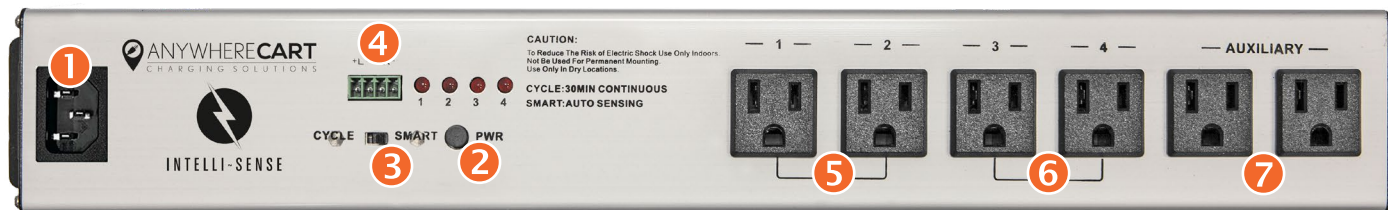

- 1** Power Input
- 2** Internal Power Button
- 3** Mode Selection Switch
- 4** External Cable Port
- 5** Cycle Outlets "A"
- 6** Cycle Outlets "B"
- 7** Auxiliary Outlets (Always ON)

QUICK START TIPS

1. Plug in device adapters so there are an equal number of devices in Group A and Group B.
 2. Make sure the Mode Selection Switch is set to "SMART" mode.
 3. Plug in cart.
- The Intelli-Sense timer will automatically sense the charging needs of the cart and start charging in the most efficient and quickest method.

Within 5 seconds of plugging in your cart's power cord, your INTELLI-SENSE Smart Charging System will initiate an test of your devices charging level requirements.

Devices which are plugged into power strips that draw the most power will take priority and can take up to 2 hours before switching to the next set of outlets. Once devices are fully charged, the system will remain in a trickle charging state, maintaining your devices battery levels.

With Mode Selection Switch set to **SMART**:

Group Outlets "A" and Group Outlets "B" power on for 8 seconds in sequence then enter the following modes depending on current draw.

Group Outlets "A"	Group Outlets "B"
7 Amp load ON ↓	5.5 Amp load OFF
5 Amp load OFF	5.5 Amp load ON ↓
5 Amp load ON ↓	4.5 Amp load OFF
4.5 Amp load ON	4.5 Amp load ON

If the total current draw is greater than 9A:
The group outlets with the highest current draw will power on, while the group with less current draw remains OFF. Once the current draw difference is within 0.5A, the system will switch to the other group. When the total current is less than 9A, all outlets will power on at the same time.

If the total current draw is less than 9A:
Group "A" and Group "B" power on at the same time. The total output is continuously monitored in case a new device is added.

NOTE: If wattage exceeds 14 Amps or about 1400 Watts at one time, the charging system may not operate correctly. Review your device's AC Adapter wattage, multiplying it by 18.

65 Watts
X
18 Devices
1170 Watts

75 Watts
X
18 Devices
1350 Watts

85 Watts
X
18 Devices
1530 Watts

- 1 Using a ruler, measure the width of your device.



- 2 If device is thicker than 1", locate & remove thumbscrews on shelf.

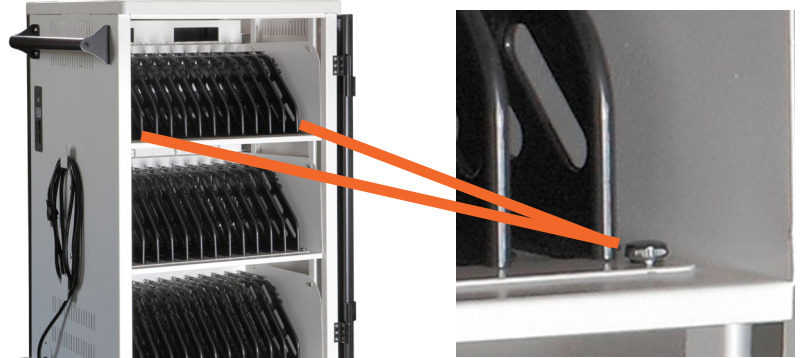

- 3 Remove Retaining Strip.

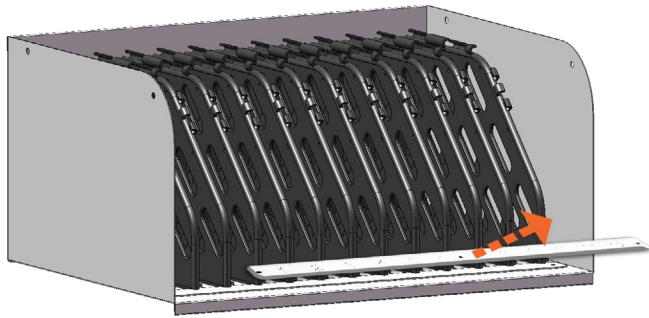

- 4 Pull forward, then up to remove the Divider.

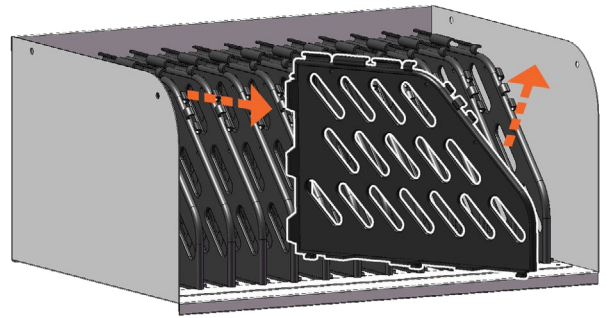

- 5 Adjust spacing as needed.

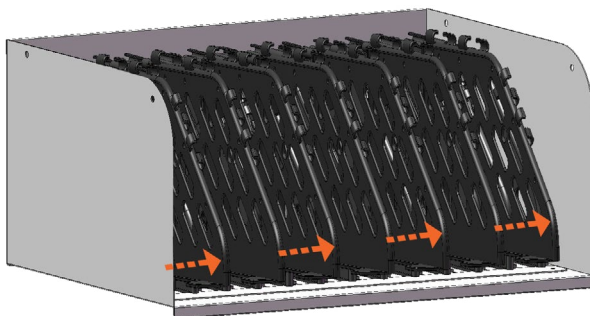

- 6 Place Strip in position & replace thumbscrews.

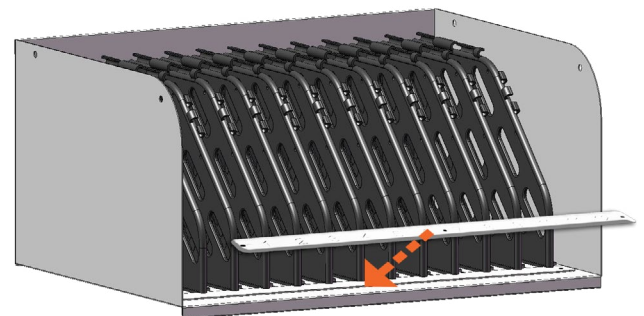

- 1 Remove basket by pulling forward first, then pull upward.

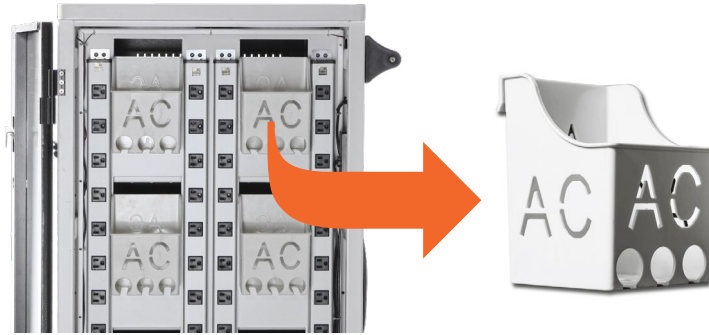

- 2 If your device power adapters are “brick” style, feed power cables through holes and place no more than 6 into a basket.



- 3 Hook basket(s) in place & distribute power cords so that all power strips have an equal number of devices plugged in.



- 4 Feed device cables into pass-thru slots to front of cart.



- 5 Working up front, weave device cables into divider tabs.



- 6 Use the supplied Cable Clips to fasten each cable to the divider by pressing down firmly, securing the cable in place.

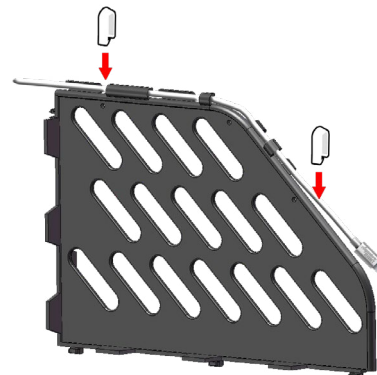

Your cart is equipped with Casters that have an “Orange” color foot pedal.

- 1 Engage the Directional Locking Casters by pressing the orange foot pedal down. Your cart will now easily track in a straight line.
- 2 Release the Direction Lock by lifting up on the foot pedal. The cart will have its full swivel motion restored.

Directional Locking



Press the **BLACK** foot pedal to lock the wheels and keep the cart in place



Press the **ORANGE** foot pedal for easy, smooth straight-line motion

- Hallways
- Around Campus
- Long Distances

Full Swivel



Release the **BLACK** foot pedal for a precise, swivel motion

- In the Classroom
- Tight Spaces
- Short Distances



Release the **ORANGE** foot pedal for a precise, swivel motion

- In the Classroom
- Tight Spaces
- Short Distances



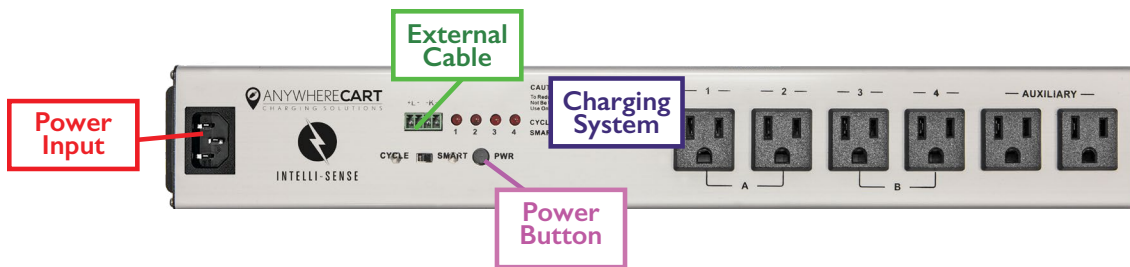

External LED Button is flashing green and devices are not charging

- 1 Overload Protection Mode has been activated.
- 2 Verify devices don't exceed 1400 watts at one time by multiplying your device's AC adapter wattage by 18.
- 3 Reduce the number of devices if necessary and resume charging.



Testing the Power Cord

Power Cord - Part # 1320399

- 1 Check the main Power Cord into the **Power Input** port located on the left side of the **Charging System** to verify it is secure.
- 2 Plug the cart into a wall outlet and press the internal **Power Button** labeled **PWR** directly on the **Charging System**.
- 3 If the system does not power on, test your Power Cord by removing it and plugging in a PC monitor style IEC Power Cord.



Testing the Power Strips

9 Outlet Power Strip - Part #1320953

- 1 Open the rear panel door and locate the 4 vertically mounted **Power Strips**.
- 2 Verify each switch is in the "RESET" position, not the "OFF" position.
- 3 Using an extension cord, test each **Power Strip** by unplugging each cord from the charging system and plugging them into the extension cord.
- 4 If one or more **Power Strips** no longer works, replace as needed.



Testing the External Power Button

External Power Button - Part # 1321375

- 1 With your cart plugged in, open the rear panel door and press the internal **Power Button** labeled **PWR** on the charging system.
- 2 If your cart powers on, unplug the **External Cable** from **Charging System**.
- 3 Using a small flat head screwdriver, ensure all individual wires are secure.
- 4 Plug the **External Cable** back in and press the External Power Button.
- 5 If the External Power Button does not light up or power on, replace it.

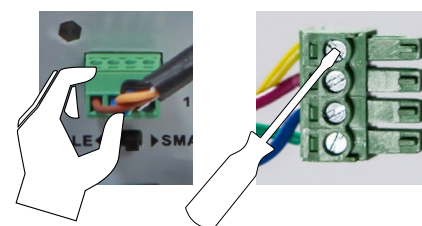

Limited Warranty

1. The terms below shall have the following definitions for purposes of this Warranty:

"Client" means the original party purchasing the Products from Anywhere Cart or from an authorized dealer to sell Anywhere Cart branded products.

"Components" mean the mechanical components of a Product including the wheels, locks, drawer slides and hinges.

"Electronics" mean the electronic timer, Sync station and power strips. Cords and switches are not warranted.

"Frame" means the main frame or chassis of a Product.

"Products" means any goods and any related services to be supplied by Anywhere Cart to the Client pursuant to the Acceptance of an Order and any other goods or services which Anywhere Cart supplies to the Client from time to time.

Anywhere Cart warrants that the Products to be supplied to Client are free from defects in material and workmanship under normal use and service for which they were intended if, but only if, the Products have been properly installed and operated. Anywhere Cart's obligation under this Warranty is limited to only supplying replacement part(s) for any part(s) which are returned and found to be defective, provided that such part(s) are returned to Anywhere Cart within the following Warranty Period:

a. With regard to the Frame, the Warranty Period shall be for the life of the Product to Client.

b. With regard to Components, the Warranty Period shall be for a period of two (2) years from the date of delivery of the Product to Client.

c. With regard to Electronics, the Warranty Period shall be for a period of two (2) years from the date of delivery of the Product to Client.

Except as prohibited or limited by applicable law, Anywhere Cart does not warrant that the Products meet the requirements of any safety code of any country, state, municipality, or other jurisdiction, and Client assumes all risk and liability whatsoever resulting from the use thereof, whether used singly or in combination with other machines or apparatus. This Warranty shall not apply to any of Anywhere Cart's Products, or parts thereof, which have been repaired or altered, without Anywhere Cart's written consent, outside Anywhere Cart's facility or altered in any way so as, in the sole judgment of Anywhere Cart, to adversely affect the stability or reliability of the Products, or if such Products have been subject to misuse, negligence, or accident, or have been operated in a manner not in accordance with Anywhere Cart's printed instructions or have been operated under conditions more severe than, or otherwise exceeding, those set forth in the specifications for such Products.

EXCEPT AS PROHIBITED OR LIMITED BY APPLICABLE LAW, THIS WARRANTY AND THE OBLIGATIONS AND LIABILITIES OF Anywhere Cart ARE EXCLUSIVE AND IN LIEU OF WARRANTIES, GUARANTIES OR LIABILITIES, EXPRESS OR IMPLIED, INCLUDING ANY IMPLIED WARRANTY FOR MERCHANTABILITY, FITNESS FOR A PARTICULAR PURPOSE, ARISING BY LAW OR OTHERWISE OR WHETHER OR NOT OCCASIONED BY Anywhere Cart's NEGLIGENCE AND CLIENT HEREBY WAIVES ALL REMEDIES NOT EXPRESSLY PROVIDED IN THIS WARRANTY. THIS WARRANTY SHALL NOT BE EXTENDED, ALTERED OR VARIED EXCEPT BY A WRITTEN INSTRUMENT SIGNED BY Anywhere Cart AND CLIENT. REGARDLESS OF THE FAILURE OF THE SOLE AND EXCLUSIVE REMEDIES PROVIDED IN THIS WARRANTY, Anywhere Cart WILL NOT BE LIABLE FOR ANY SPECIAL, INCIDENTAL, INDIRECT OR CONSEQUENTIAL DAMAGES WHATSOEVER (INCLUDING, WITHOUT LIMITATION, DAMAGES FOR LOSS OF REVENUE, BUSINESS OR PROFITS, LOSS RESULTING FROM BUSINESS INTERRUPTION, LOSS OF BUSINESS INFORMATION, LOSS RESULTING FROM ANY CLAIM BY ANY THIRD PARTY, ANY LOSS DUE TO DAMAGE TO PROPERTY, AND INJURY TO OR DEATH OF ANY PERSONS RESULTING, DIRECTLY OR INDIRECTLY, FROM THE USE OR LOSS OF THE PRODUCTS OR ANY OTHER PECUNIARY LOSS) OF ANY KIND OR NATURE. Anywhere Cart NEITHER ASSUMES NOR AUTHORIZES ANY PERSON TO ASSUME FOR IT ANY OTHER LIABILITY IN CONNECTION WITH THE SALE OR USE OF THE PRODUCTS, AND THERE ARE NO ORAL AGREEMENTS OR WARRANTIES COLLATERAL TO OR AFFECTING THIS WARRANTY. THE EXCLUSION OF SPECIAL, INCIDENTAL, INDIRECT OR CONSEQUENTIAL DAMAGES IS AN INDEPENDENT AGREEMENT OF Anywhere Cart AND CLIENT APART FROM THE SOLE AND EXCLUSIVE REMEDIES PROVIDED IN THIS WARRANTY.

Client shall notify Anywhere Cart by registered or certified mail, return receipt requested, of a breach of this Warranty within thirty (30) days after discovery thereof, but not later than the expiration of the applicable Warranty Period, otherwise such claims shall be deemed waived.

2. Limitations of Warranty.

Anywhere Cart makes no warranties to any third party. You are responsible for all claims, damages, settlements, expenses, and attorneys' fees with respect to claims made against You as a result of Your use or misuse of the Product. This warranty applies only if the Product is installed, operated, maintained, and used in accordance with Anywhere Cart specifications. Specifically, the warranties do not extend to any failure caused by (i) accident, unusual physical, electrical, or electromagnetic stress, neglect or misuse, (ii) fluctuations in electrical power beyond Anywhere Cart specifications, (iii) use of the Product with any accessories or options not furnished by Anywhere Cart or its authorized agents, or (iv) installation, alteration, or repair of the Product by anyone other than Anywhere Cart or its authorized agents.

3. Disclaimer of Warranty.

Except As Expressly Provided Otherwise Herein And To The Maximum Extent Permitted By Applicable Law, Anywhere Cart Disclaims All Other Warranties With Respect To The Product, Whether Express, Implied, Statutory Or Otherwise, Including Without Limitation, Satisfactory Quality, Course Of Dealing, Trade Usage Or Practice Or The Implied Warranties Of Merchantability, Fitness For A Particular Purpose Or Noninfringement Of Third Party Rights.

4. Limitation of Liability.

In no event shall Anywhere Cart be liable for indirect, incidental, special, exemplary, punitive, or consequential damages of any nature including, but not limited to, loss of profits, data, revenue, production, or use, business interruption, or procurement of substitute goods or services arising out of or in connection with this limited warranty, or the use or performance of any product, whether based on contract or tort, including negligence, or any other legal theory, even if Anywhere Cart has advised of the possibility of such damages. Anywhere Cart's total, aggregate liability for damages of any nature, regardless of form of action, shall in no event exceed the amount paid by you to Anywhere Cart for the specific product upon which liability is based.

5. Governing Law and Your Rights.

This warranty gives You specific legal rights; You may also have other rights granted under state law. These rights vary from state to state.

6. Warranty Period for Anywhere Cart Product Purchased:

AC-SLIM, AC-MAX	Lifetime Frame, 2 Years Components, 2 Year Electronics
-----------------	--